

Important Information

General

Before using your **ALGE-TIMING** device read the complete manual carefully. It is part of the device and contains important information about installation, safety and its intended use. This manual cannot cover all conceivable applications. For further information or in case of problems that are mentioned not at all or not sufficiently detailed, please contact your **ALGE-TIMING** representative. You can find contact details on our homepage www.alge-timing.com

Safety

Apart from the information of this manual all general safety and accident prevention regulations of the legislator must be taken into account.

The device must only be used by trained persons. The setting-up and installation must only be executed according to the manufacturer's data.

Intended Use

The device must only be used for its intended applications. Technical modifications and any misuse are prohibited because of the risks involved! **ALGE-TIMING** is not liable for damages that are caused by improper use or incorrect operation.

Power supply

The stated voltage on the type plate must correspond to voltage of the power source. Check all connections and plugs before usage. Damaged connection wires must be replaced immediately by an authorized electrician. The device must only be connected to an electric supply that has been installed by an electrician according to IEC 60364-1. Never touch the mains plug with wet hands! Never touch live parts!

Cleaning

Please clean the outside of the device only with a smooth cloth. Detergents can cause damage. Never submerge in water, never open or clean with wet cloth. The cleaning must not be carried out by hose or high-pressure (risk of short circuits or other damage).

Liability Limitations

All technical information, data and information for installation and operation correspond to the latest status at time of printing and are made in all conscience considering our past experience and knowledge. Information, pictures and description do not entitle to base any claims. The manufacturer is not liable for damage due to failure to observe the manual, improper use, incorrect repairs, technical modifications, use of unauthorized spare parts. Translations are made in all conscience. We assume no liability for translation mistakes, even if the translation is carried out by us or on our behalf.

Disposal

If a label is placed on the device showing a crossed out dustbin on wheels (see drawing), the European directive 2002/96/EG applies for this device.

Please get informed about the applicable regulations for separate collection of electrical

and electronical waste in your country and do not dispose of the old devices as household waste. Correct disposal of old equipment protects the environment and humans against negative consequences!



Copyright by **ALGE-TIMING GmbH**

All rights reserved. Any duplication, either in full or in part, requires the prior written consent of the copyright holder.

Subject to changes!

Copyright by:
ALGE-TIMING GmbH
Rotkreuzstrasse 39
A-6890 Lustenau
Austria

office@alge-timing.com
www.alge-timing.com

Table of contents

| | | |
|--------|--|----|
| 1 | Software-License | 4 |
| 2 | System-Setup..... | 5 |
| 2.1 | Schematic..... | 5 |
| 2.1.1 | Single-sided timing with numeric display board..... | 5 |
| 2.1.2 | Double-sided timing with matrix-display | 6 |
| 3 | USB-Driver Installation..... | 7 |
| 3.1 | Standard Installation..... | 7 |
| 3.2 | Installation after quitting once the installation..... | 10 |
| 4 | Finding the right COM-Port!..... | 11 |
| 5 | Simple-Timing and Timing-Manager | 13 |
| 5.1 | Start..... | 13 |
| 5.1.1 | Competition selection | 13 |
| 5.2 | Initialize SWC | 15 |
| 5.3 | Settings for the competition | 15 |
| 5.3.1 | Options-Settings-Limit-Time | 15 |
| 5.3.2 | Options-Settings-General | 16 |
| 5.3.3 | Hardware | 17 |
| 5.3.4 | Options-Settings-Other..... | 19 |
| 5.4 | Options-Edit start times | 19 |
| 5.5 | Options-Change paper | 19 |
| 5.6 | Displayboard..... | 19 |
| 5.7 | Event-display | 19 |
| 5.8 | Direct output | 20 |
| 5.8.1 | Presentation ceremony (only Timing-Manager)..... | 20 |
| 5.8.2 | Special..... | 20 |
| 5.9 | Result | 20 |
| 5.10 | Deactivate timing | 20 |
| 5.11 | Advanced Settings..... | 21 |
| 5.11.1 | HW.ini | 21 |
| 5.11.2 | Com.ini..... | 21 |
| 5.11.3 | Standard.txt | 22 |
| 5.12 | Emergency-mode | 22 |
| 5.12.1 | Reprint..... | 22 |
| 5.12.2 | Set ready | 22 |
| 6 | SWIM-Manager | 22 |
| 6.1 | Create competition | 22 |
| 6.1.1 | Empty competition | 22 |
| 6.1.2 | Competition based on template..... | 22 |
| 6.1.3 | Open last competition..... | 22 |
| 6.1.4 | Open an existing..... | 22 |
| 6.2 | Menu competition | 23 |
| 6.2.1 | Prepare competition..... | 23 |
| 6.2.2 | Import competition structure | 24 |
| 6.3 | Competition-jury | 24 |
| 6.3.2 | Intermediate times | 25 |
| 6.3.3 | Additional event-info | 25 |
| 6.3.4 | Define limits | 25 |
| 6.4 | Menu prepare | 25 |
| 6.4.1 | Register competitors..... | 25 |
| 6.4.2 | Import competitors..... | 26 |
| 6.4.3 | Create start list..... | 26 |
| 6.4.4 | Check start list | 26 |

| | | |
|-------|--|----|
| 6.4.5 | Manual start-list reordering | 26 |
| 6.4.6 | Print lists | 26 |
| 6.4.7 | Organization | 27 |
| 6.5 | Menu Rating | 27 |
| 6.5.1 | Late registrations | 27 |
| 6.5.2 | Cancellations | 27 |
| 6.5.3 | Read timing..... | 28 |
| 6.5.4 | Print results..... | 28 |
| 6.5.5 | Overview..... | 28 |
| 6.5.6 | Semi-final..... | 28 |
| 6.5.7 | Finale..... | 28 |
| 6.6 | Extras | 28 |
| 6.6.1 | Export data | 28 |
| 6.7 | Special functions | 29 |
| 6.7.1 | Export of HTML files | 29 |
| 7 | Certificate..... | 29 |
| 7.1 | Insert text..... | 30 |
| 7.2 | Insert graphic..... | 30 |
| 7.3 | Insert datafield (Datenbankfeld) | 30 |
| 7.4 | Insert a formula..... | 30 |
| 8 | Designer..... | 31 |
| 9 | Technical data..... | 32 |
| 9.1 | SWC SWIM CONTROLLER..... | 32 |
| 9.1.1 | Interface-describtion | 32 |
| 10 | Maintenance | 32 |

Welcome at **ALGE** SWIM2000, the most effective timing system for competitive swimming. Works on Windows 95/98/NT/2000 and XP. With **ALGE** SWIM2000 you are able to carry out your competitions faster than ever before.

1 Software-License

The complete Software-Package **ALGE-SWIM2000** is Freeware. But to be able to print lists you have to register your username at **ALGE-TIMING**. Please send an e-mail with your data to office@alge-timing.com to receive your free license.

After you receive the license-file you have to copy this file into the program directory of SWIM2000.

Standard installation path is C:\Program Files\ALGE-TIMING\SWIM2000

2 System-Setup

As we developed the ALGE SWIM2000 timing-system we took special care on an easy and logical setup of the system.

2.1 Schematic

Depending on the accessories you have there can be some difference to the shown drawings.

2.1.1 Single-sided timing with numeric display board

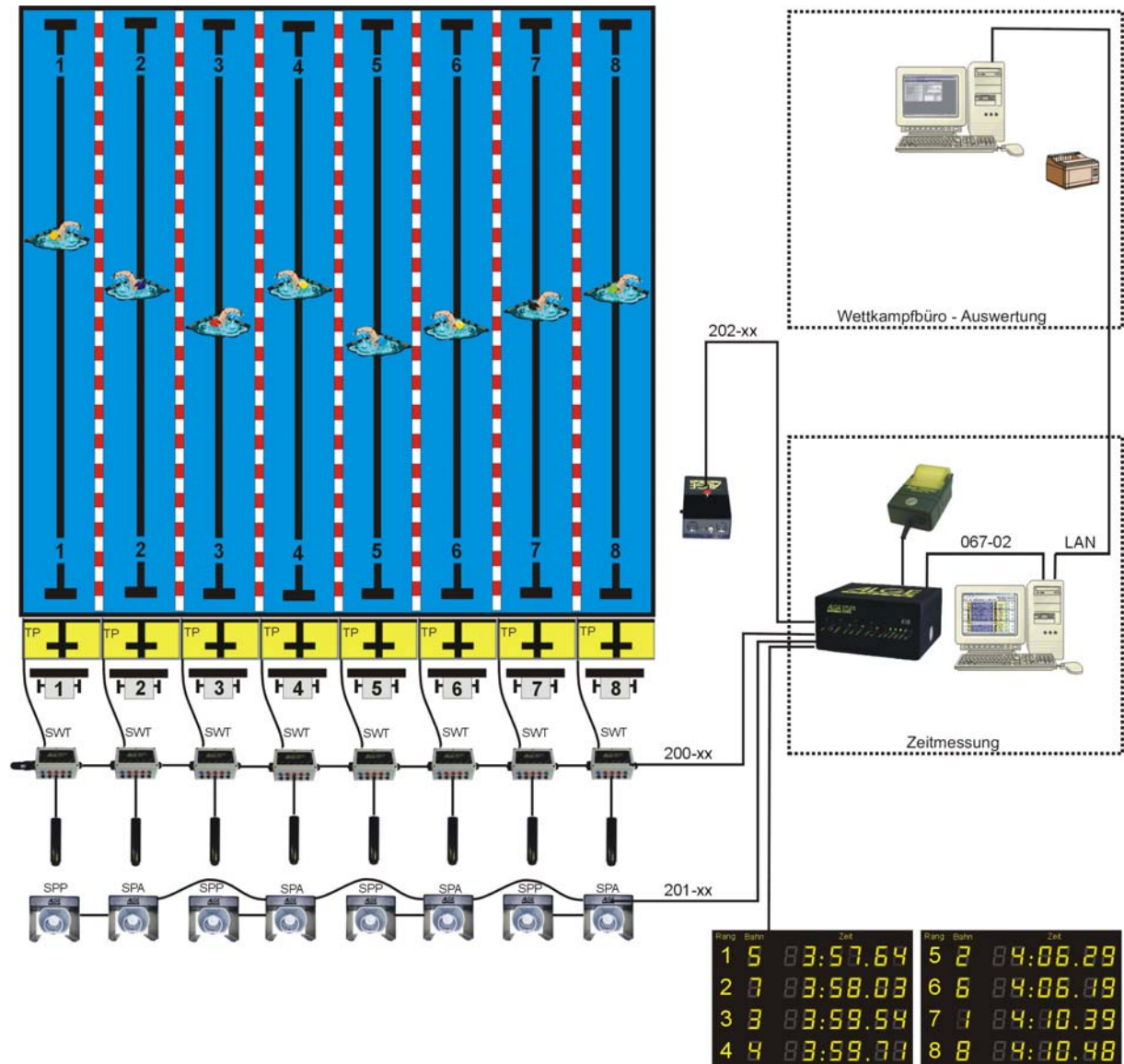

2.1.2 Double-sided timing with matrix-display

Depending on the accessories you have there can be some difference to this drawing.

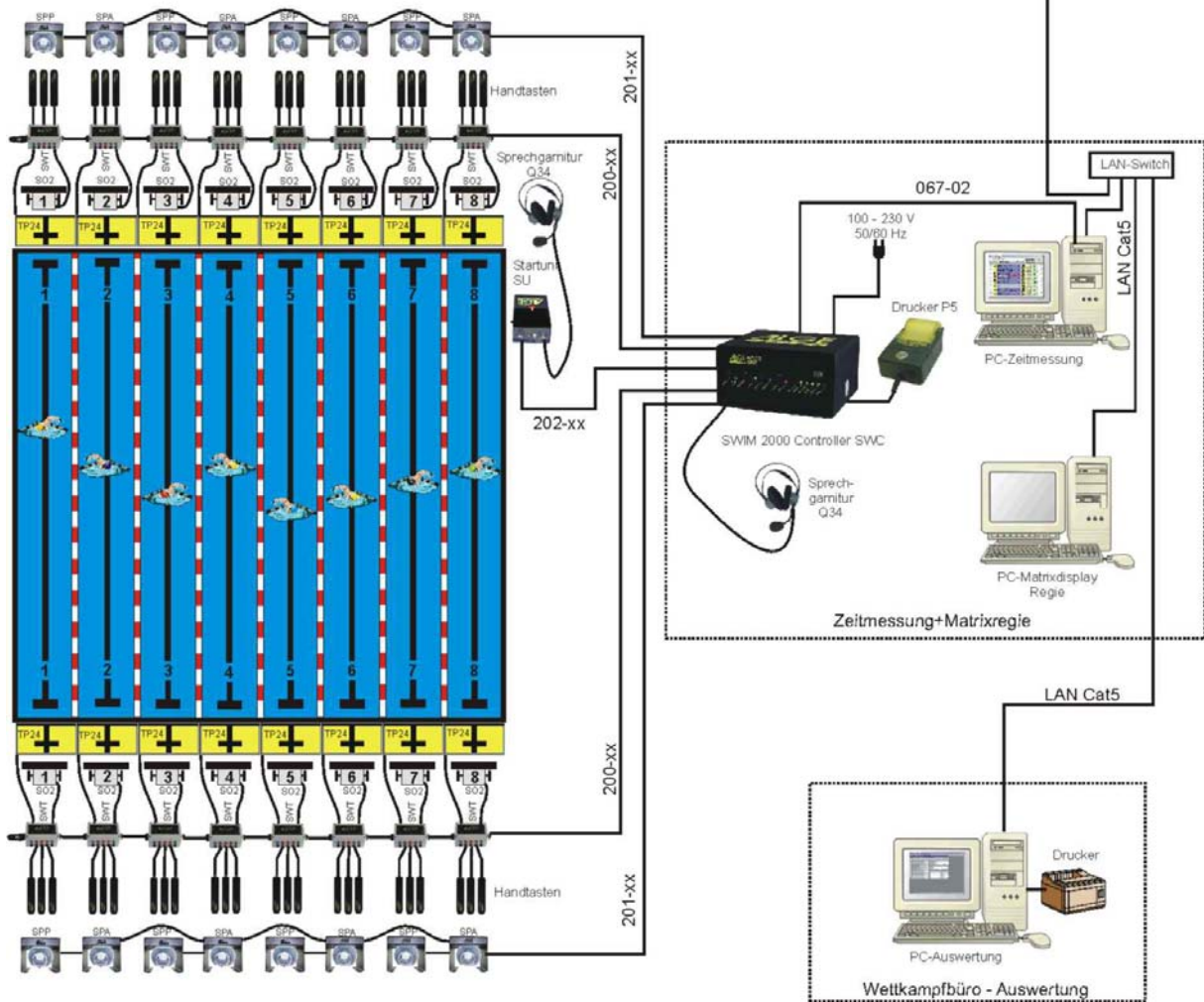

3 USB-Driver Installation

To run the TMS on your Computer you need to install the USB-Driver for the TMS. There are 2 possibilities how to install the driver. Below you can find both possibilities.

3.1 Standard Installation

- Insert the ALGE-CD into your CD-Drive.
- Connect at least 4 Terminals to your TMS and connect also the SWT-END-Plug to the last Terminal SWT.
- Now connect the TMS with the USB-Cable to your computer.
- Switch on the TMS now.
- The Window for new Hardware found will pop up within a few seconds.
- *If the Window for New Hardware will not pop up automatically continue with point 3.2*

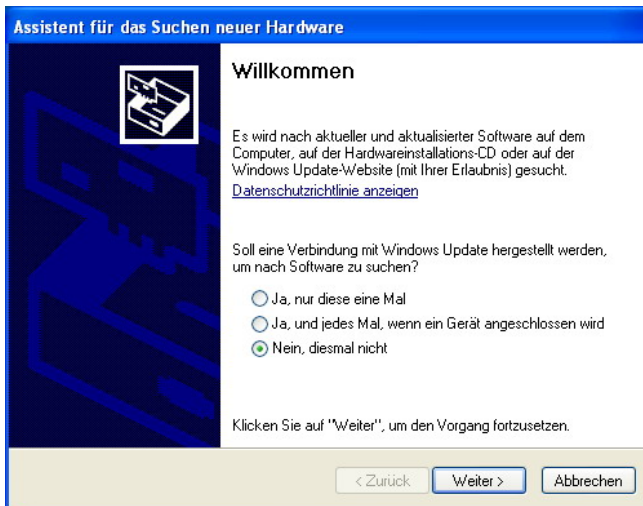

- Choose the option “do not connect to the Internet, then continue

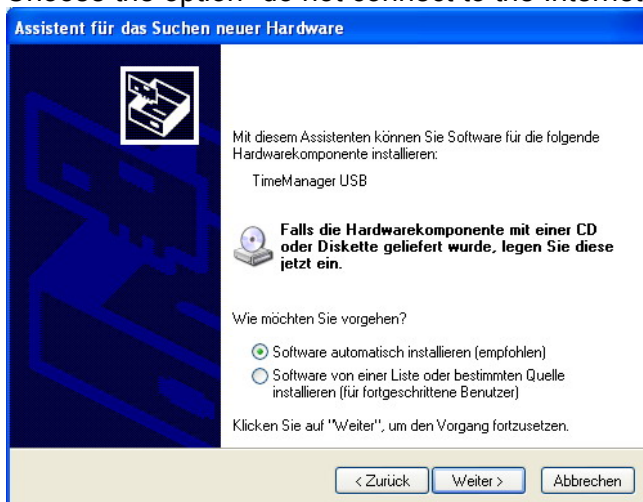

- Choose the option “Install Software automatically” and presses continue.
- Windows will now search the driver on the CD and install it automatically.

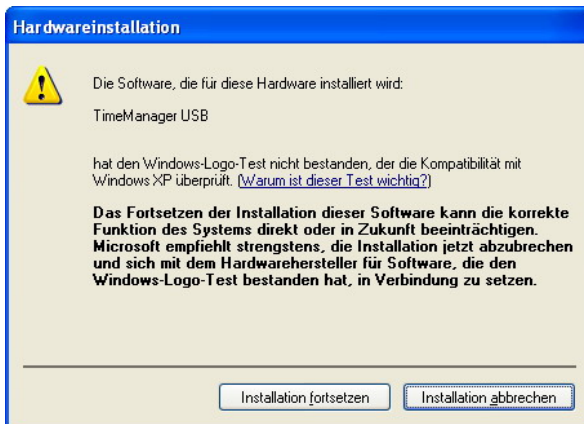

- After a while Windows will tell you that this Software has not passed the Windows LOGO-Test. Press on “Continue installation”



- After a few more seconds Windows will inform you that the driver was installed successfully. Click on ready.
- Windows will inform you now that it found a new devices.
- The Window for new Hardware found will pop up again.

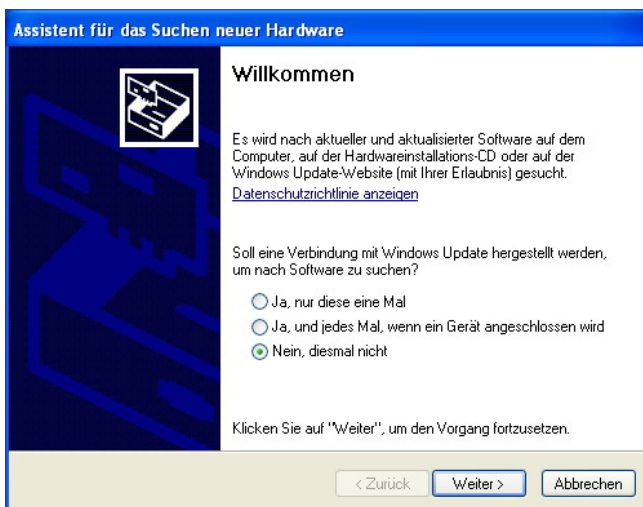

- Choose the option “do not connect to the Internet, then continue

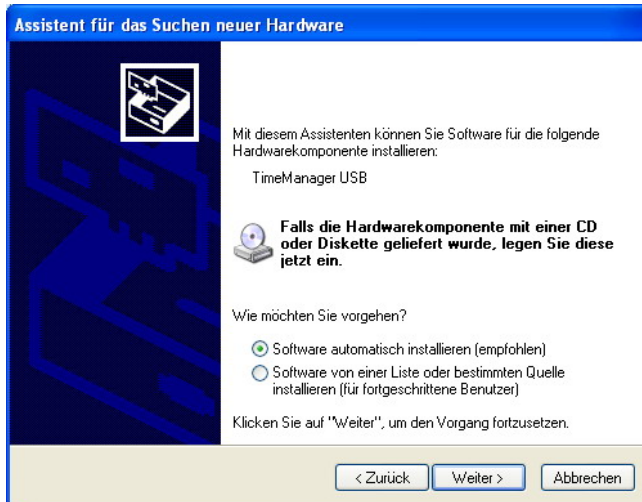

- Choose the option “Install Software automatically” and press continue.
- Windows will now search the driver on the CD and install it automatically.



- After a while Windows will tell you that this Software has not passed the Windows LOGO-Test. Press on “Continue installation”



- After a few more seconds Windows will inform you that the driver was installed successfully. Click on ready.
- Now the driver is installed successfully and you can use the Timing-System.

3.2 Installation after quitting once the installation

- Insert the ALGE-CD into your CD-Drive.
- Connect at least 4 Terminals to your TMS and connect also the SWT-END-Plug to the last Terminal SWT.
- Now connect the TMS with the USB-Cable to your computer.
- Switch on the TMS now.
- The Window for new Hardware found will not pop up automatically!
- Click on “Start – Controlpanel”

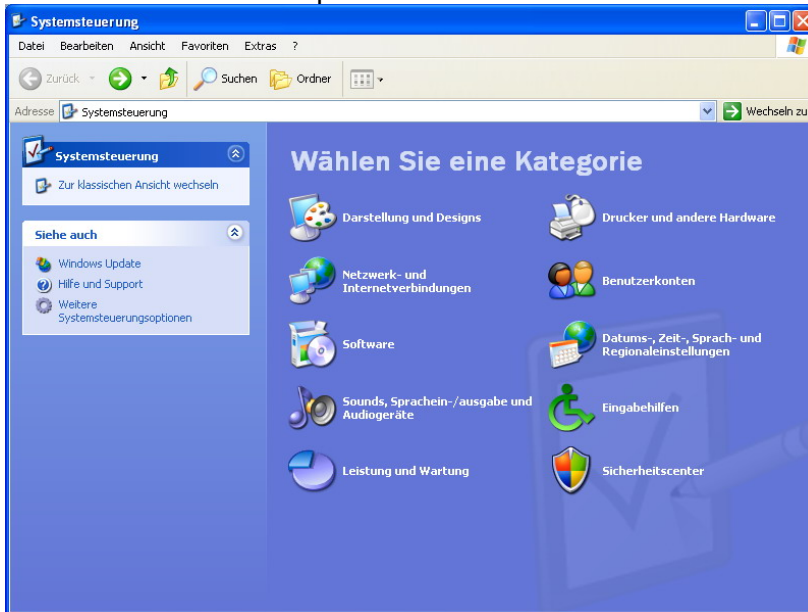

- Click now on the Icon for Printer and other hardware.

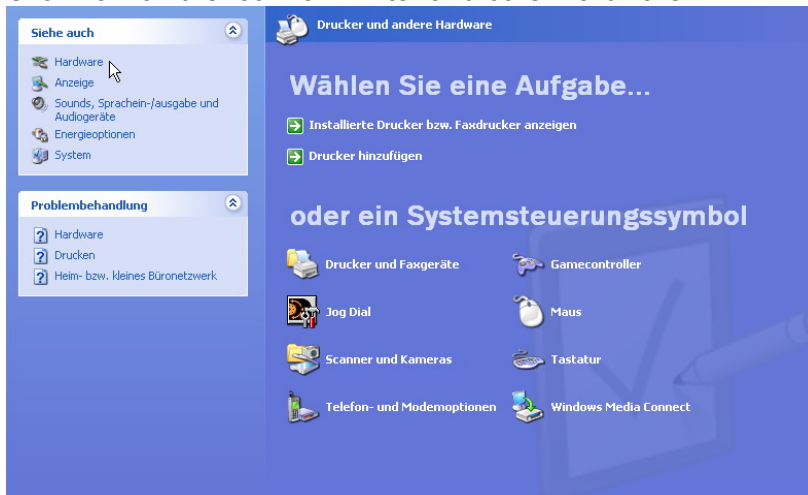

- In the next window click on the small Icon for Hardware in the left top section of the window.

- The Window to install new Hardware will now pop up.

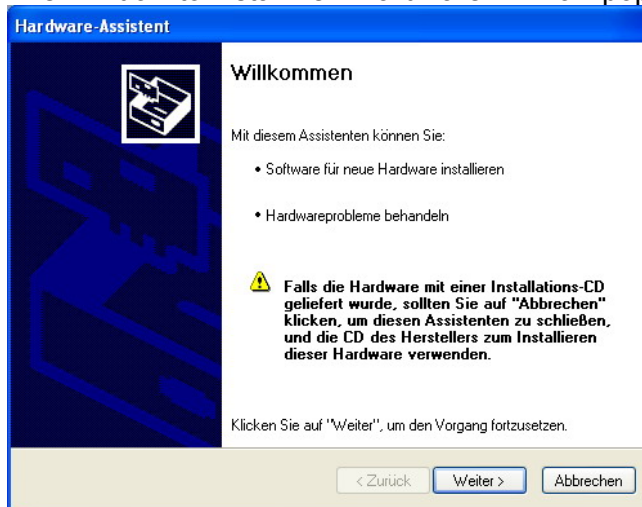

- Press the button “Continue”
- The Computer will now search for new hardware, after a few seconds the Window for the Installation of the new hardware will pop up.
- Continue now as described under point 3.1

4 Finding the right COM-Port!

After Installation of the USB-Driver for the TMS you need to know which virtual Com-Port you choose in the swimming-Software for the Connection.

- Right-Click on Start, now press on “Explorer”



- Right-Click now on “My Computer” and then on properties



- Click on “Hardware” and then on “Device Manager”

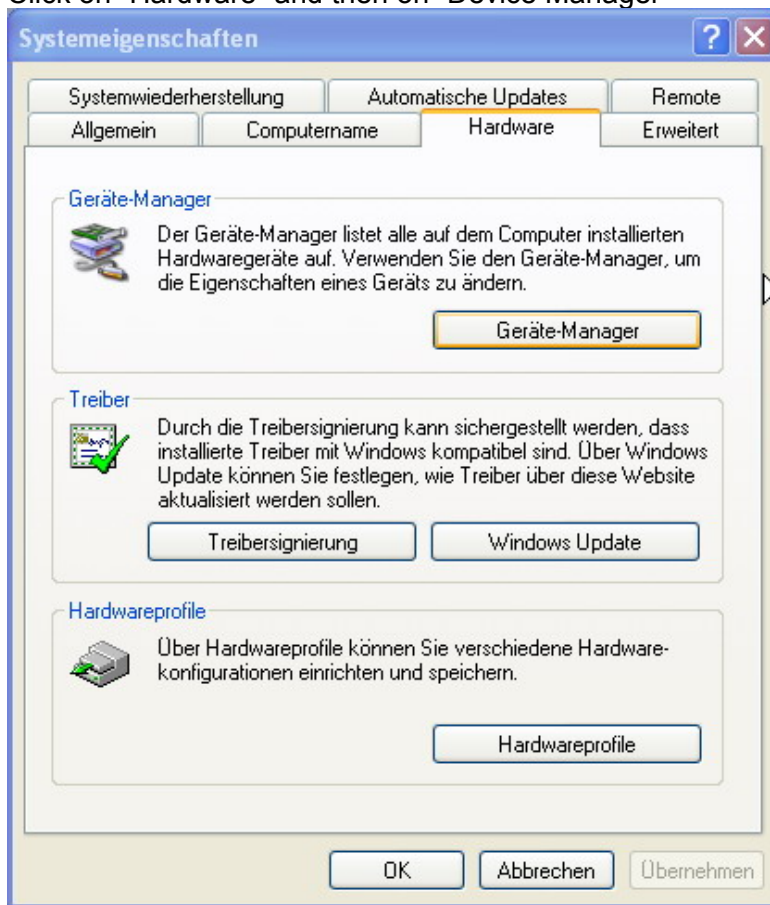

- Click now on Connections and COM-Ports

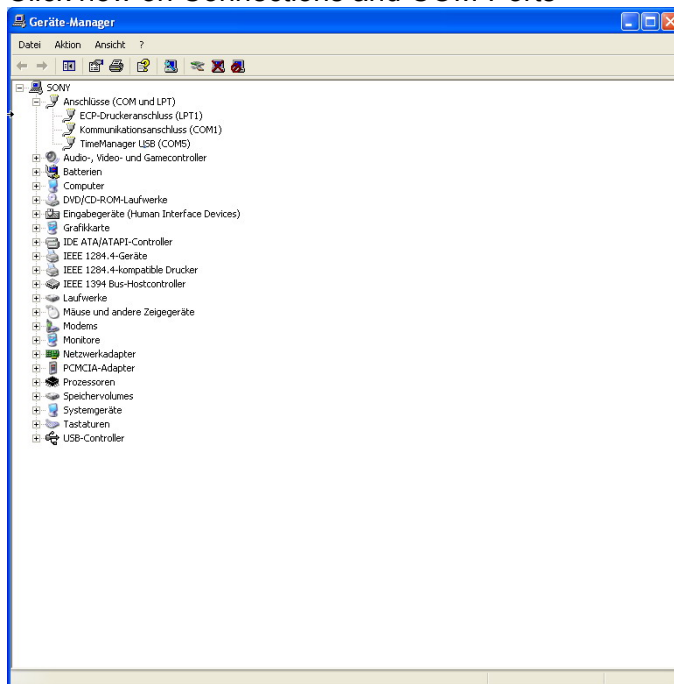

- You can see now the COM-Port which is used by the TMS. Use this COM-Port in the Window described under Point 5.2.

5 Simple-Timing and Timing-Manager

The timing software is only display and keyboard for the high accurate timing-device ALGE SWC, which is working with a temperature compensated quartz oscillator (TCXO). To ensure this high accuracy we recommend sending the SWC for calibration to ALGE-TIMING any 3-5 years.

For the timing you have 2 different programs.

The program Timing-Manager is in connection with the evaluation software Meet-Manager the perfect solution for any kind of competitions.

If you work with an evaluation-software from a 3rd party you have to work with Simple-Timing. As these two programs are nearly identically we describe the in one manual.

5.1 Start

Double-click on the Icon of the Timing-Manager or Simple-Timing program.

You find these programs also under START-PROGRAMS-ALGE-TIMING-SWIM2000.

5.1.1 Competition selection

You have 2 possibilities to open a competition. With Simple-Timing you can also create a new competition.

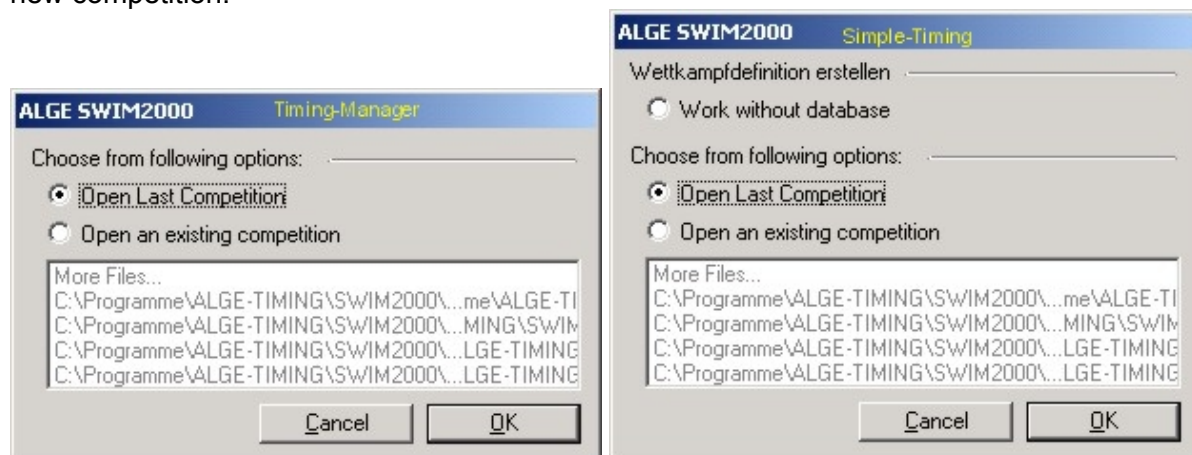

5.1.1.1 Open last competition

This function will open automatically the last opened competition-file.

- ☞ Mark this option and click the button OK.
- ☞ Attention! This function is at the first program start not available!
- ☞ Continue with point 5.2 (Timing-Manager)
- ☞ Continue with point 5.1.1.4 (Simple-Timing)

5.1.1.2 Open an existing competition

With this function you can browse your folders to find any competition.

- ☞ Mark this option and click the button OK.
- ☞ Choose the path where your competition is saved.
- ☞ Standard path is *C:/Program Files/ALGE-TIMING/SWIM2000/Work*. You can also find a sample-competition in this directory.
- ☞ Double-click on the file or mark the file and click on OK.
- ☞ Continue with point 5.2 (Timing-Manager)
- ☞ Continue with point 5.1.1.4 (Simple-Timing)

5.1.1.3 Create new competition (only with Simple-Timing)

With this function you can create your own competition-file if you are not working with the Meet-Manager.

- ☞ Mark this option and click the button OK.
- ☞ Input a name for the competition and choose the path where you want to save this competition.

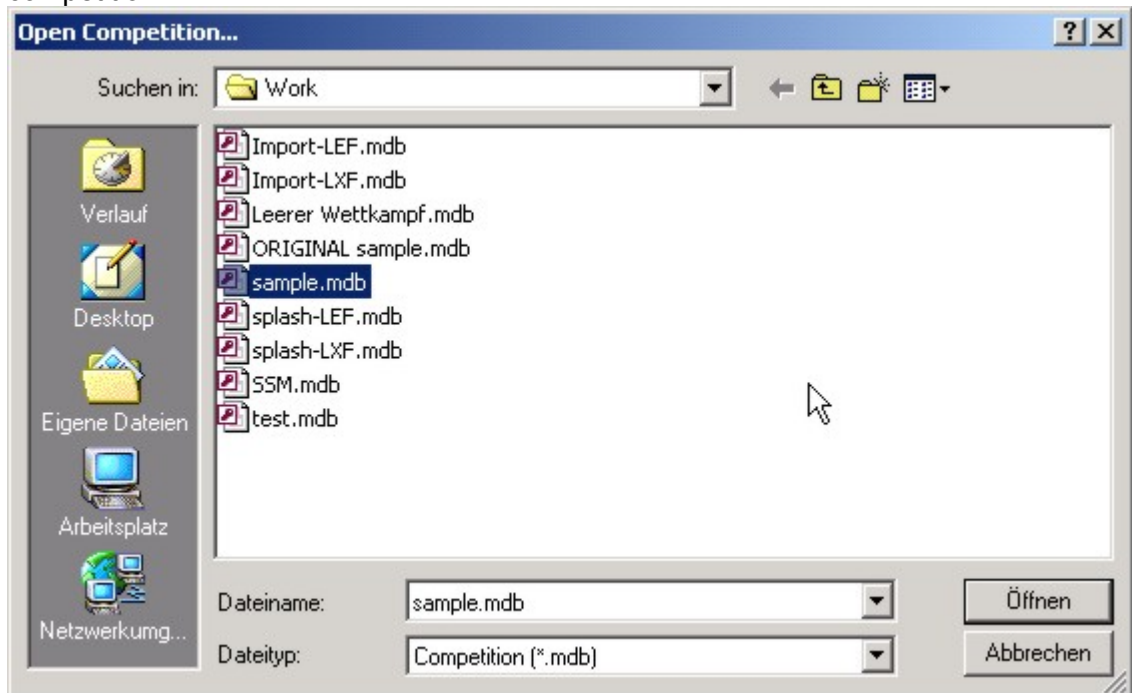

- ☞ Now you have to edit the competition-structure
- ☞ Continue with point 5.2 (Timing-Manager)
- ☞ Continue with point 5.1.1.4 (Simple-Timing)

5.1.1.4 Edit event (only Simple-Timing)

With this function you have to create your own competition-structure.

For changing's you can reach this window also under *competition-create competition*.

- ☞ Click the button *new event*.
- ☞ Choose the distance
- ☞ Choose the discipline
- ☞ Choose the sex
- ☞ Input the amount of heats
- ☞ Click the button *save event*
- ☞ Input the complete competition-structure
- ☞ Continue with point 5.2



5.2 Initialize SWC

The SWC will do an automatic self-test and the PC will send the daytime to the SWC.

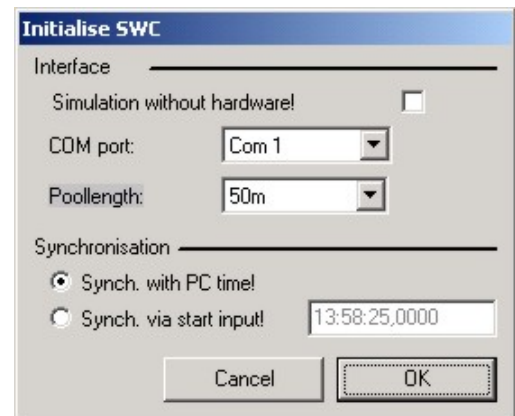

5.2.1.1 Simulation mode without hardware

With this mode you can play with the software without connected hardware. It is used only for demonstration.

ATTENTION! With this mode you cannot time any race or simulate any output to the numeric display boards.

5.2.1.2 Standard-Port

Choose the Com-Port where you have connected the SWC.

5.2.1.3 Pool length (only with Simple-Timing)

Simple Timing needs this setting to calculate the amount of touches concerning the distance.

5.2.1.4 Synchronization with PC-Time

Choose this option if you don't have a second system for backup.

5.2.1.5 Synchronization via start input

With this option you can synchronize more ALGE Timing-devices with the same daytime. Connect all Start-inputs of you devices, set them on the same daytime and press the internal start button of the SWC to start all systems synchronous.

5.3 Settings for the competition

It is important to know what possibilities you have with ALGE SWIM2000. All the special functions can be adjusted here.

Your individual setting is saved in the PC when you turn on the system next time.

5.3.1 Options-Settings-Limit-Time

5.3.1.1 Relay-take-off

Our examinations and the examinations of other timing-companies have shown that the real take-off-time shows a difference between 0.023 and 0.027 Seconds compared with high-resolution video-systems. For that reason we recommend to tolerate a relay-take-off time of -0.03 seconds.

This setting does not affect the measured times it is only red color marking if bigger than this tolerance.

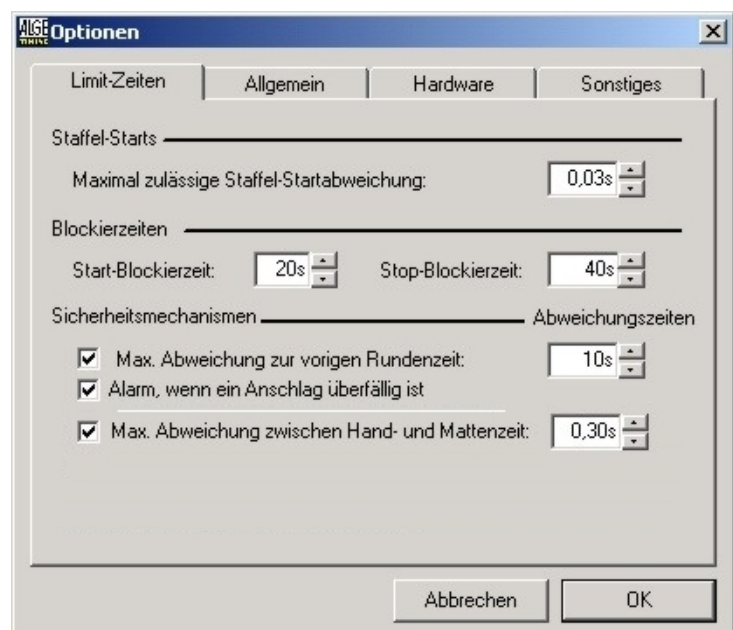

5.3.1.2 Start Block Time

The system will register after the start for this time no valid touchpad time for any lane.

5.3.1.3 Stop Block Time

After a valid touch on a touchpad, the SWC register for the same touchpad within this time no valid time. All registered times within the block time have no touch number and are marked with a u on the online-printer.

5.3.1.4 Difference to last lap

If the actual lap-time disappears more than this time it will warn the user with a red colored time at this lane. You don't have to react on this if the time is correct.

With the checkbox you can activate or deactivate this function.

5.3.1.5 Alarm if touch is overdue

If there is no touch after the last lap time + difference time it will warn the user.

This can occur if a swimmer turns under the touchpad for example. It is also only a warning for the user to find easy any possible mistakes.

5.3.1.6 Maximum tolerance between touchpad and manual button

We recommend using 0,30 seconds for this setting. In general the manual buttons disappear between 0,10 to 0,35 seconds. But 0,35 is a big difference where you have tell the timekeepers to be more concentrated.

5.3.2 Options-Settings-General

5.3.2.1 Automatic protocol printing

To activate the automatic protocol printing on a PC-Printer you have to mark this checkbox.

The printout can be sorted by lane or by rank.

In most counties the judges don't like these type of protocol because they think it is easy to forge such a protocol.

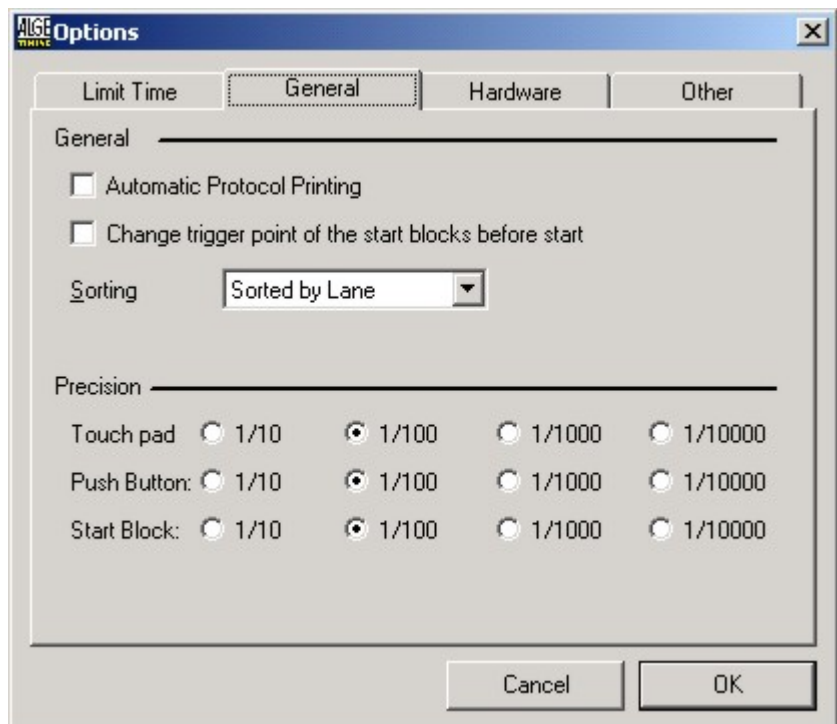

5.3.2.2 Change trigger point before start

Normally the SWC is registering only the take-off of at the starting block. With this function the SWC is able to measure at the first start the reaction time of the swimmer. After the swimmer gives a pressure of more than 5 kilo the SWC will register a time and compare this to the start-time. This can be used especially for training to measure the reaction time

5.3.2.3 Precision

Depending on the national rules you can adjust the output precision of the different timing-channels.

ATTENTION! This setting will not affect the precision of the printed start-impulses and the impulses that are registered if the SWC is ready for start. If you have to calculate run times out of the daytimes you need to calculate with the full precision and cut after the calculation.

5.3.3 Hardware

5.3.3.1 Settings – GAZ

- **Intensity:**
 - To adjust the brightness on your display board D-XXXX
 - **Modus:**
 - Lane 1-A
 - LANE ORIENTED
 - Displayboard addresses from 1- A, the running time will be shown on display 1 until the first touch is registered, then display 1 shows the intermediate-time for the display-time and the running time jumps to the next free display. After display 1 is free the running time came back to this line.
 - Rank 1-A - STANDARD
 - RANK ORIENTED
 - Displayboard addresses from 1- A
 - The times will be shown on the line of the lane number. If a touch is on lane 1 the running time will jump to the next free Displayboard. Intermediate times will be display for the display time.
 - Run lane 0-A
 - LANE ORIENTED, as lane 1-A, but running time is shown always on Displayboard 0
 - Run rank 0-A
 - RANK ORIENTED, as rank 1-A, but running time is shown always on Displayboard 0
 - GAZ48xx
 - Reserve
 - 2xGAZ46xx
 - SINGLE-LINE
 - All times will be displayed on a single start number-rank-time display, which is normally used for skiing.
 - 1xGAZ48xx
 - SINGLE-LINE
 - All finish times will be displayed on line 1, only the leading intermediate time is displayed.
- For a detailed setup drawing of the display boards you have to see in the manual of the Displayboard.

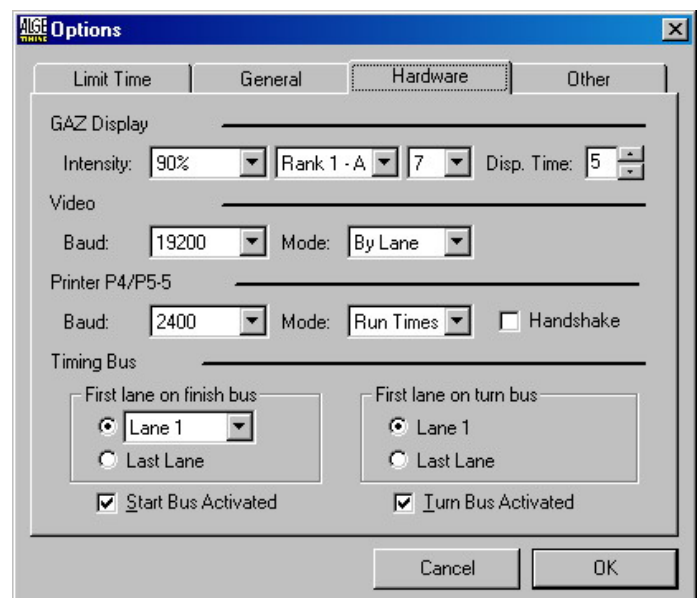

5.3.3.2 Settings – Video

Baud rate:

- ☞ Standard 19200
- ☞ option: 4800,9600,19200

Modus:

- ☞ Lanes
- ☞ priority has the running time, all intermediates will be sent between the running strings.
- ☞ Rank
- ☞ priority has the running time, all intermediates will be sent between the running strings.

5.3.3.3 Settings – Printer

Baud rate:

- ☞ Standard: 2400
- ☞ option: 4800,9600,19200

Modus:

- ☞ Run times – STANDARD
- ☞ All registered times will be printed out in run times. Start times and invalid times which are registered in the ready for start mode are printed in daytime
- ☞ Daytime
- ☞ All registered times will be printed in daytimes!
- ☞ ATTENTION! If you use a 3rd party evaluation software which read the data of the printer interface you have to check if this mode is supported!
- ☞ Handshake
- ☞ Depending on the connected printer you can switch on or off hardware handshake.

5.3.3.4 Settings Timing Bus

- ☞ Reading direction
- ☞ As the SWT's have no internal numbering you have to tell the system whether you have connected lane 1 or the last lane in your setup.
- ☞ Finish-Start Bus active
- ☞ With this checkbox you can switch the complete timing bus on or off.

5.3.4 Options-Settings-Other

Here you can find the flash-version and the software version you are actually using.

- ☞ Flash-Rom-Update
- ☞ With this function you can update the flash.
- ☞ *ATTENTION! Never use this function during a running competition! After you start the update you will loose all times of the actual heat!*

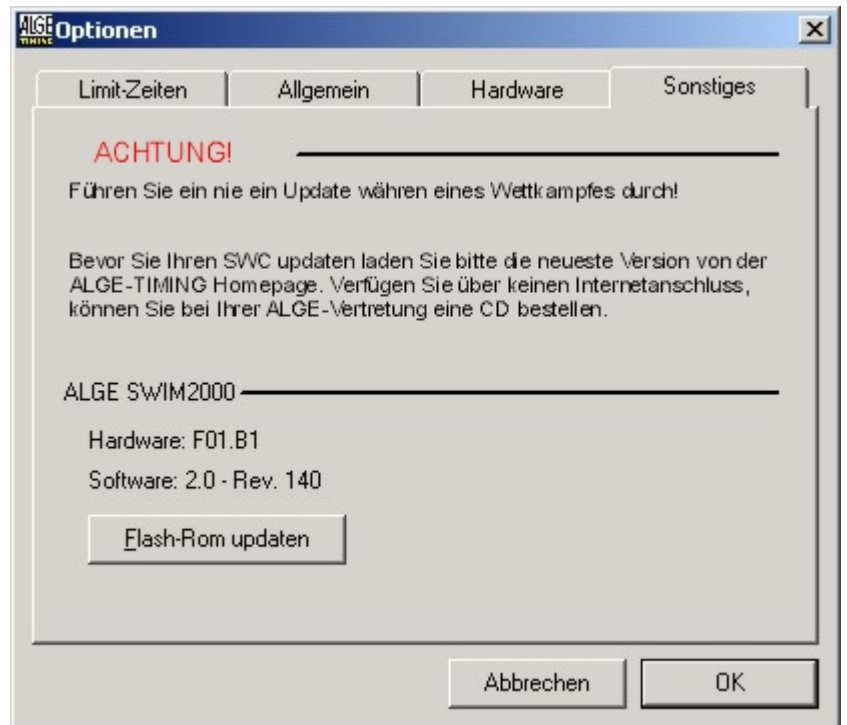

5.4 Options-Edit start times

Choose the correct start-time and press the OK button. The SWC will recalculate all times after that function.

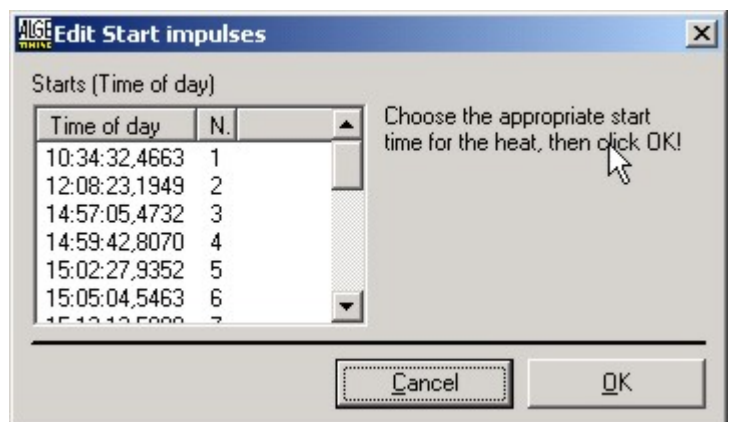

5.5 Options-Change paper

Activate this checkbox if you're running out of paper. After you have inserted new paper all registered times will be printed out.

5.6 Displayboard

ATTENTION! This function depends on the Displayboard you are using. This function can't be used for numeric display boards.

5.7 Event-display

ATTENTION! This option can be used only with numeric display boards to show the event and heat number. The display has to be connected on COM2 of the PC.



5.8 Direct output

ATTENTION! This function is only with numeric displays possible.

General

Choose the desired option and press the button *show*.

Text

Numeric displays can show also some text. Letters that can't be displayed will be ignored.

Daytime

During the warm up you can display the daytime on one of the display boards.

Standard text

Here you can choose a predefined text. To change the text please see point 5.11.3

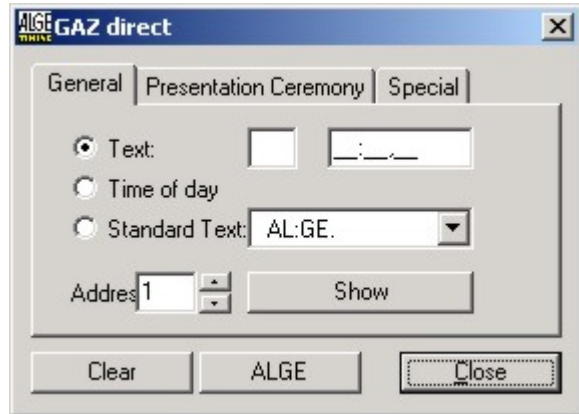

5.8.1 Presentation ceremony (only Timing-Manager)

Choose the event you want display and send rank by rank on the Displayboard.

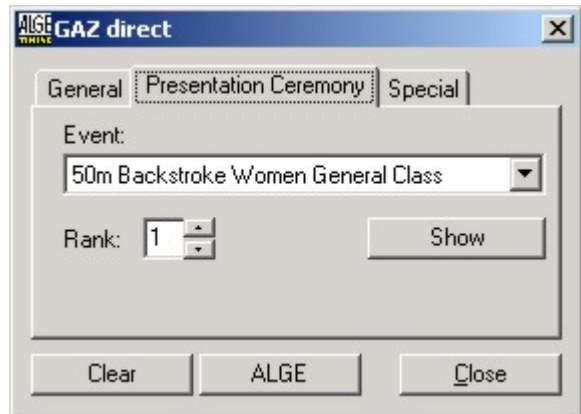

5.8.2 Special

With this function you can operate the Displayboard after a long period of no competitions.

5.9 Result

With this function you can display the results of any finished heat.

5.10 Deactivate timing

During the warm up you can switch the timing completely of.

Use this function that your database will not grow to a huge size during the warm up.

5.11 Advanced Settings

ATTENTIO! These settings are only for skilled users. Do not make any changing until you make a copy of the original files.

5.11.1 HW.ini

You can find this file under the program directory of SWIM2000.

- ☞ [Hardware]
- ☞ This is no setting.
- ☞ TotzeitMatten=200
- ☞ Delay time for touchpads in ms, 200ms are 2 Seconds
- ☞ TotzeitHandtaster=030
- ☞ Delay time for manual buttons in ms, 030ms are 0,3 Seconds
- ☞ TotzeitStart=020
- ☞ Delay time for start button in ms, 020ms are 0,2 Seconds
- ☞ TotzeitStartHandtaster=015
- ☞ Delay time for internal start button in ms, 020ms are 0,2 Seconds
- ☞ Kanaldauerauslösung=10
- ☞ Allowed time for continuous impulse
- ☞ Fehlstartzeit=2
- ☞ Size of the timing window for the relay-start channel
- ☞ Mattenflanke=0
- ☞ trigger point for touchpads. 0...close, 1...open
- ☞ Handtasterflanke=0
- ☞ trigger point for manual buttons. 0...close, 1...open
- ☞ Startflanke1=0
- ☞ trigger point for relay-start-channel before the start signal. 0...close, 1...open
- ☞ Startflanke2=1
- ☞ trigger point for relay-start. 0...close, 1...open
- ☞ LautsprecherSignal=020
- ☞ Duration of the start signal on the speakers
- ☞ KopfhörerSignal=020
- ☞ Duration of the start signal in the headphone. If somebody makes a early relay-start the headset will give a repeating beep

5.11.2 Com.ini

With this file you can set some special functions for a separate Displayboard.

- ☞ [CommPort-Setup]
- ☞ This is no setting. It is used by the software to know that it is the correct file.
- ☞ Enabled=1
- ☞ Different functions are available.
- ☞ 0... off; 1...Event display, see point 5.7; 2...Display board, see point 5.6
- ☞ Port=1
- ☞ choose the desired port
- ☞ Handshake=0
- ☞ Handshake on of off
- ☞ Settings=9600,n,8,1
- ☞ Baud rate of interface

5.11.3 Standard.txt

In this file you can insert the text you want to display with the standard text function. See point 5.8.

```
AL:GE.  
AS:CS.  
Ar:bo.n  
1234:56.78
```

5.12 Emergency-mode

As all the time keeping is made inside the SWC we developed an emergency mode where you can work even without a computer.

All settings will be standard **ALGE**-settings

Please take care on the reading direction of the timing bus. If you have connected the last lane first the lanes will be wrong. 1 is 8, 2 is 7,...

5.12.1 Reprint

To get a second copy of the online-printer press the internal start button until you hear a single beep (5 sec.). After that the SWC will reprint all times starting at the last valid start time.

5.12.2 Set ready

After any finished heat you have to press the internal start button until you hear a double-beep. After that the SWC will be ready for the next event.

6 SWIM-Manager

The evaluation program will do all the work in organizing your competition. From the registrations to the start bill, start lists...

6.1 Create competition

To carry out a competition you have to define the competition first. Choose one of the following steps to open or create a competition file.

6.1.1 Empty competition

With this function you can create your own new competition file.

- ☞ Afterwards you have to insert a file-name.
- ☞ Continue with point

6.1.2 Competition based on template

Choose this function if you already have a template for your competition.

- ☞ Choose a template from the catalog.
- ☞ Choose a target directory and a file name.
- ☞ Continue with point

6.1.3 Open last competition

Open automatically the last opened competition.

6.1.4 Open an existing...

Open an existing competition.

To search a competition-file click on *additional files*, to browse your disk.

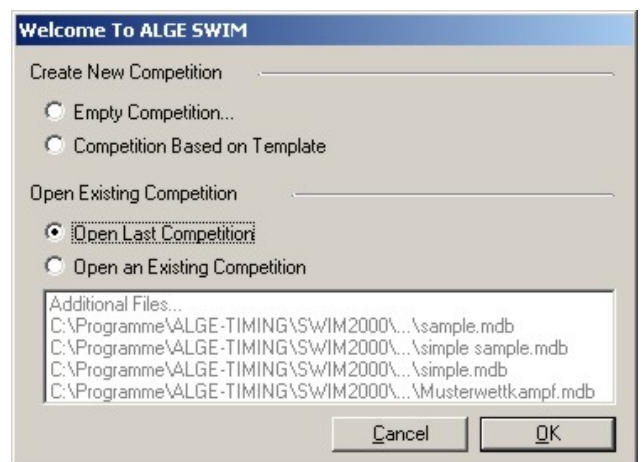

6.2 Menu competition

6.2.1 Prepare competition

In this point you have to input the complete structure of your competition, like events, age groups, semi-finals, finals and the order of events.

You can also import a competition-structure from an existing competition-file, see point 6.2.2. ATTENTION! If you enter this point with a ready calculated start-list you have to recalculate the start list if you do any changing's.

6.2.1.1 Age-groups

Here you have to define all age groups, which are competing at this event.

- ☞ Click on *new class* or press **Alt+N** on the keyboard.
- ☞ Insert a name for the new age-group
- ☞ Choose the start and end year of birth of this age-group
- ☞ Click on *save class* or press **Alt+S** on the keyboard.

6.2.1.2 Events

Create here all your events.

ATTENTION! Semi-finals and finals are part of the preliminary or timed events.

- ☞ Click on *new event* or press **Alt+N**!
- ☞ Choose a distance out of the pull-down menu.
- ☞ Choose a discipline!
- ☞ Choose the sex!
- ☞ Choose the type of seeding!
- ☞ Print details on lists!
- ☞ Choose the rule for the seeding!
- ☞ Click on *save event* or press **Alt+S**.
- ☞ To change entries you have to mark the one you want change, change the settings and click on *save event* or press **Alt+S**.

6.2.1.3 Designate age-groups

You have to designate to any event at least one age-group

- ☞ Mark the event you want to work.
- ☞ Press **Ctrl** to mark more than one event.
- ☞ Press **Shift** to mark from the last marked event to this event.
- ☞ Mark now the classes you want to designate to the marked events.
- ☞ Press **Ctrl** to mark more than one class.
- ☞ Press **Shift** to mark from the last marked class to this class.
- ☞ Click now on *CLASS>>>* to designate the marked classes to the marked events.
- ☞ If there are no semi-finals or finals continue at point 6.2.1.6.
- ☞ To change setting, mark the setting and change.

6.2.1.4 Create semi-final

If you don't have semi-finals in your competition proceed with point 6.2.2.

- ☞ Choose the display-filter: Show only preliminaries, timed or both types of competition.
- ☞ Click on *new semi-final* or press **Alt+N**!
- ☞ Choose the event where you want to add a semi-final.
- ☞ Choose type of seeding.
- ☞ Choose the order of heats!
- ☞ Print details on or off!
- ☞ Amount of semi-final heats.
- ☞ Click on *save semi-final* or press **Alt+S**.
- ☞ To change semi-finals, mark and change the desired one.

6.2.1.5 Create finals

If your competition has no finals proceed with point 6.2.1.6.

- ☞ Choose the display-filter: Show only preliminaries, timed or both types of competition.
- ☞ Click on *new final* or press **Alt+N**!
- ☞ Choose the event where you want to add a final.
- ☞ Choose type of seeding.
- ☞ Choose the order of heats!
- ☞ Print details on or off!
- ☞ Click on *save final* or press **Alt+S**.
- ☞ To change finals, mark and change the desired one

6.2.1.6 Chronological order

Change the order of you events against your preconditions. You can add here also competition-parts. In the Point 6.3.1.1 you can add the date to each competition-part.

- ☞ Shift event.
- ☞ Mark the event you want shift.
- ☞ With the arrow-buttons you can move the position of the events or competition-parts.
- ☞ Insert competition part
- ☞ Mark the first event of the new competition-part and click on
- ☞ Click on the button *new comp.-part*.
- ☞ Overview
- ☞ Here you can see the class designation of any event.
- ☞ With *Ready* you save the competition structure.
- ☞ To change any data, mark and change the designated one.

6.2.2 Import competition structure

With this function you can import a competition-structure from a LENEX-File.

- ☞ Click on *Read competition structure!*
- ☞ Choose the path and the file you want import.
- ☞ Prove the imported structure as described under point 6.2.

6.3 Competition-jury

Here you have to enter all judges and details of the competition.

6.3.1.1 Competition

- ☞ Competition name (for all comp-part the same)
- ☞ Additional (for all comp-part the same)
- ☞ Venue (for all comp-part the same)
- ☞ Entry-Date
- ☞ Date
- ☞ Time for warm-up and start of competition part.
- ☞ Technical details concerning the pool

6.3.1.2 Jury

- | | |
|-------------------------|--------------------|
| ☞ Chief of organization | ☞ Finish judge |
| ☞ Technical chief | ☞ Speaker |
| ☞ Referee | ☞ Starter |
| ☞ Swim judge | ☞ False start rope |

6.3.1.3 Timers

- ☞ Chief of timekeepers
- ☞ Timekeepers

6.3.1.4 Protocol

- ☞ Timing-device
- ☞ Operator
- ☞ Protocol
- ☞ Evaluation
- ☞ Certificate

6.3.2 Intermediate times

Here you have to define which intermediate-times shall be printed in the result-list.

- ☞ Intermediate-times are printed only if print details is activated! See point 6.2.1.
- ☞ For relays you have to use also the last touch as intermediate time to get the single-runtime of the last swimmer.

6.3.3 Additional event-info

With this function you are able to input all the records you want show on the results.

- ☞ Choose the competition where you want to print additional information.
- ☞ Click on *new information* or press **Alt+N**!
- ☞ Choose Information out of the pull-down menu or overwrite this text.
- ☞ Input additional information.
- ☞ Click on *save information* or press **Alt+S**.
- ☞ To change any entries, mark and change the designated one, then click on *save information* or press **Alt+S**.

6.3.4 Define limits

Input the limits for any discipline and class.

6.4 Menu prepare

Here you will find anything from registrations of swimmers over organization-function to start lists and registration lists.

6.4.1 Register competitors

Here you can manually enter all the swimmers and relay-team data.

If you import the registrations from a LENEX-file see point 6.4.2.

6.4.1.1 Swimmers

Input all registration information for any swimmer!

- ☞ Click on **▶*** or press **Alt+N**!
- ☞ Input the name, club, nation, sex and year of birth of the swimmer
- ☞ Save your entry with **▶!**, **↵** or **Alt+S**!
- ☞ Choose now the event, from the pull-down menu, where you want to register the swimmer. To register the swimmer you have to input a registration-time. If you have no time you have to input 99:99.99. ATTENTION! Only the events are available where the age group of the swimmer is valid.
- ☞ With **▶*** or **Alt+N** you can proceed with the next entry.
- ☞ To change a swimmer jump with the buttons **⏪ ⏩** to the swimmer or search him with **▶?**, change the data and save again.

6.4.1.2 Relay-team

- ☞ Click on **▶*** or press **Alt+N**!
- ☞ Input the name, club, nation, sex and class of the relay-team.
- ☞ Save your entry with **▶!**, **↵** or **Alt+S**!
- ☞ Choose now the event, from the pull-down menu, where you want to register the relay-team. To register the relay-team you have to input a registration-time. If you have no time you have to input 99:99.99. ATTENTION! Only the events are available

where the age group of the relay-team is valid. With or you can proceed with the next relay-team.

- With or you can proceed with the next entry.
- To change a swimmer jump with the buttons to the swimmer or search him with , change the data and save again.

ATTENTION! The names of any relay swimmer can be entered direct in the point 6.5.3. If you can't input the name of the 4th swimmer you have to choose one more intermediate time under point 1.1.1

6.4.2 Import competitors

You can also import the registrations from a LENEX-file.

6.4.3 Create start list

Depending on the competition-rules you can calculate the start list by using the preliminary seeding-rules or the timed heat seeding-rules. If you want to seed with preliminary seeding-rule you have to define the event as preliminary heat. On many international events like the AUSTRIA-MEETING you seed only the fastest 3 heats by preliminary seeding and the rest by general seeding. This option doesn't affect timed heats.

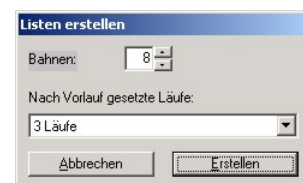

ATTENTION! If you have already calculated a start list you will lose all changing's if you recalculate the start list new.

6.4.4 Check start list

Here you can check heat by heat of the start list! It is also possible to make late registrations and cancellations in this window.

6.4.5 Manual start-list reordering

This function allows the user to rearrange the start list with Drag&Drop. Especially on Relays it can be important to have this possibility.

You can also insert a special event like an attempt on a record.

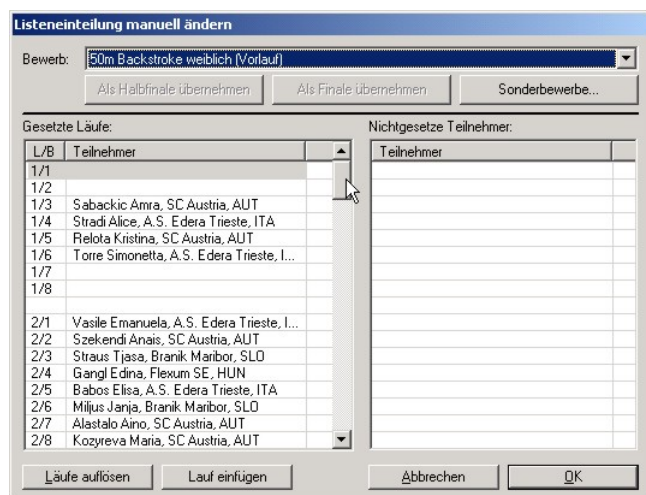

6.4.6 Print lists

6.4.6.1 Registration list

Prints all registrations of the desired events. This function is only available if you have already calculated a start list.

6.4.6.2 Start list

Prints the start list of the desired events.

ATTENTION! Semi-final and final start lists can be found under point 6.5.6 and 6.5.7.

6.4.6.3 Overview

This will print a start list on fewer pages.

6.4.6.4 Timekeeper list

The manual timekeepers use this list. All swimmers per event, which are swimming in the same lane, are on one page.

6.4.7 Organization

6.4.7.1 Statistic – Registrations

Prints a registration.

6.4.7.2 Overview – Registrations

Here you can print a statistic per club or swimmer concerning their registrations.

6.4.7.3 Schedule – Competition structure

Choose a buffer-time between heats and a break between events to allow the software a calculation of the schedule of the complete meeting. Print this list to give the swimmers a rough idea of the time-schedule.

6.4.7.4 Start bill

- ☞ Choose an amount of money, which has to be paid by the swimmers for the registration.
- ☞ Choose an amount of money, which has to be paid by the relay-teams for the registration.
- ☞ Under the point calculation you can print out the bill for clubs, swimmers or relay teams.

6.4.7.5 Fine

If a swimmer can't reach his registration-time in the event you can punish him with a fine.

6.4.7.6 Relay-Swimmers

Print out these lists to give it to the trainer or coach to enter the names of the swimmers, which are in the relay team.

6.5 Menu Rating

6.5.1 Late registrations

To register swimmers to the competition after you have already calculated the start list. You can also edit existing swimmers within this window.

- ☞ Click on *After Entry!*
- ☞ Input the swimmers data!
- ☞ Click on *save* to store the new or changed data.

Now you can manually seed the swimmer on a free lane like described under point 6.5.3.

6.5.2 Cancellations

- ☞ Choose the swimmer to cancel from the list!

- ☞ Cancel the swimmer from the whole competition or from a single event.

6.5.3 Read timing

You have to take care that the competition-file is always stored on the timing-PC. If you have a breakdown of the network the timing can continue work.

6.5.3.1 Connect

Here you connect the evaluation with the registered times of the timing-system. You can import any lane separate or you can import the whole heat. It is also possible to import a heat number 7 from the timing to the heat number 6 of the evaluation if needed.

6.5.4 Print results

- ☞ Choose the desired template for the result list.
- ☞ Choose the desired output media. (printer, preview, or Internet-HTML)
- ☞ For internet-output see also point 6.7.1.
- ☞ Choose the events you want to print.
- ☞ Choose the page number of the first page.
- ☞ Click on print to receive the lists.

6.5.5 Overview

This will print a result list ordered by lanes from any heat to compare with the manual times or other use.

6.5.6 Semi-final

6.5.6.1 Assign swimmers

6.5.6.2 Print start list

6.5.7 Finale

6.5.7.1 Assign swimmers

6.5.7.2 Print start list

6.6 Extras

6.6.1 Export data

6.6.1.1 Special ratings

- | | | | |
|-----------|---------------------|-----------|--------------------------|
| 6.6.1.1.1 | <u>Points-Cup</u> | 6.6.1.1.4 | <u>Team</u> |
| 6.6.1.1.2 | <u>Points-Best</u> | 6.6.1.1.5 | <u>Combination</u> |
| 6.6.1.1.3 | <u>Points-Limit</u> | 6.6.1.1.6 | <u>Club championship</u> |

6.6.1.2 Summary

- | | | | |
|-----------|--------------------------|-----------|-----------------|
| 6.6.1.2.1 | <u>Press</u> | 6.6.1.2.3 | <u>Overview</u> |
| 6.6.1.2.2 | <u>Medals statistics</u> | | |

6.6.1.3 Settings

6.6.1.3.1 [File-Path](#)

6.6.1.3.4 [Contact](#)

6.6.1.3.2 [Heat-Division](#)

6.6.1.3.5 [Language](#)

6.6.1.3.3 [Print](#)

6.7 Special functions

6.7.1 Export of HTML files

All lists can be published direct as HTML-files.

- ☞ Choose as output the option *Internet (HTML)*.
- ☞ Choose a path and input a filename for the HTML-output.
- ☞ We recommend to create a separate folder for the HTML-output
- ☞ Now you can choose one of the following options:
- ☞ 1 File for the complete competition or an index file plus 1 file for any event.

7 Certificate

With this unique program you can create your own Certificates or you can place the output on the fields on your preprinted certificates.

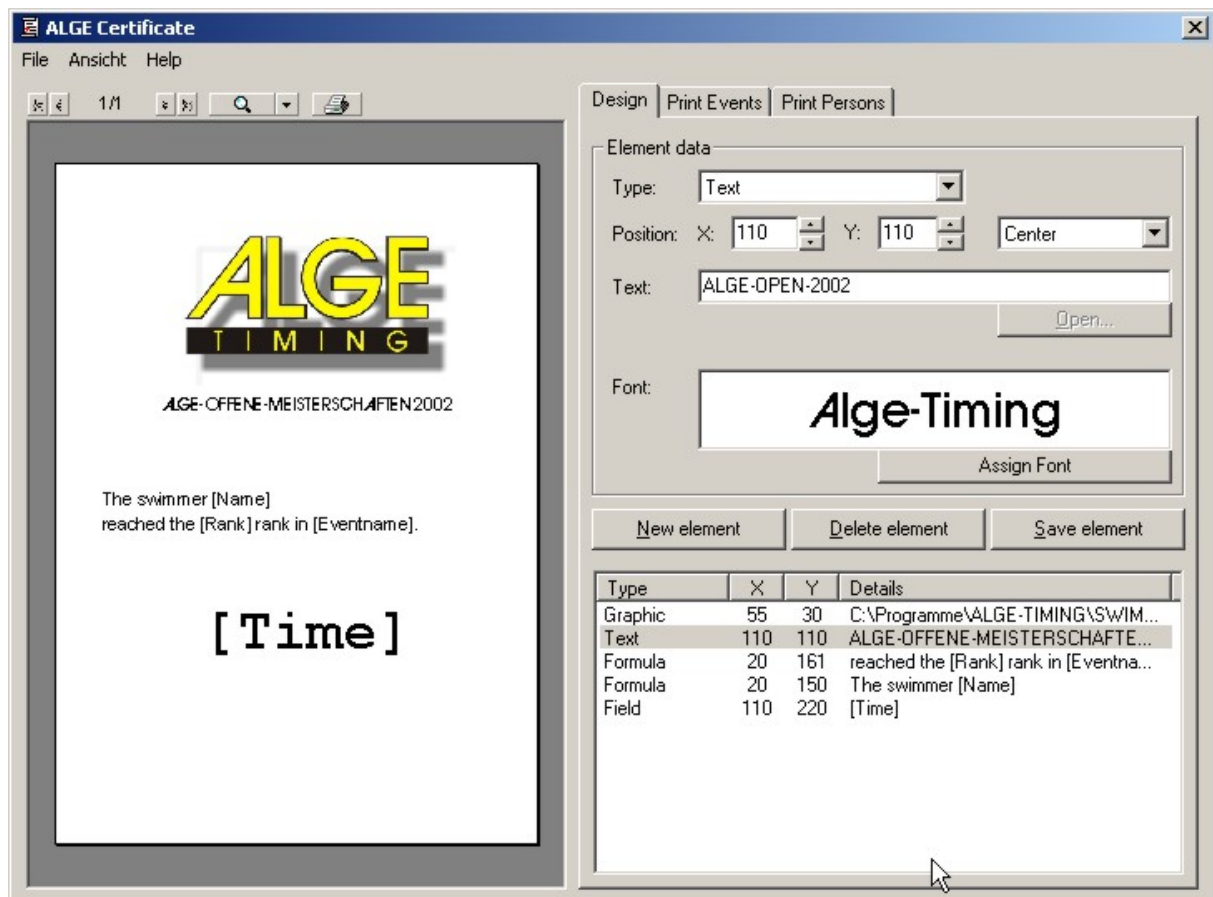

7.1 **Insert text**

- ☞ Click on *New element*
- ☞ Choose under type *Text*
- ☞ Adjust the position of the element. Example: X=110,Y=110, direction the upper left corner is the base-point.
- ☞ Input the desired text
- ☞ Z.B. ALGE-OPEN-2002
- ☞ Choose the font, grade and properties of the text.
- ☞ Click on *Save element*.
- ☞ In the preview you can see now how it looks.
- ☞ To change any entries mark the entry, change it and press *save element* again.

7.2 **Insert graphic**

- ☞ Click on *New element*
- ☞ Choose under type *Graphic*
- ☞ Adjust the position of the element. Example: X=110,Y=110, direction the upper left corner is the base-point.
- ☞ ATTENTION! Depending on the graphic the direction can give different results.
- ☞ Choose a graphic, with the button open you can search your drive for the graphic
- ☞ Click on *Save element*.
- ☞ In the preview you can see now how it looks.
- ☞ To change any entries mark the entry, change it and press *save element* again.

7.3 **Insert datafield (Datenbankfeld)**

- ☞ Click on *New element*
- ☞ Choose under type *Datenbankfeld*
- ☞ Adjust the position of the element. Example: X=110,Y=110, direction the upper left corner is the base-point.
- ☞ Click on *Save element*.
- ☞ In the preview you can see now how it looks.
- ☞ To change any entries mark the entry, change it and press *save element* again.

7.4 **Insert a formula**

- ☞ Click on *New element*
- ☞ Choose under type *Formel*
- ☞ Adjust the position of the element. Example: X=110,Y=110, direction the upper left corner is the base-point.
- ☞ Insert the formula.
- ☞ Ex. The swimmer [Name] has reached the [Rank] rank.
- ☞ Any data field, which is embedded in the formula, has to be between square brackets.
- ☞ Click on *Save element*.
- ☞ In the preview you can see now how it looks.
- ☞ To change any entries mark the entry, change it and press *save element* again.

8 Designer

With the Designer you can create your own layout for the different lists.



- ☞ Open an existing Layout-file. You can find them under the program directory SWIM2000\Layouts.
- ☞ Change the fonts as desired.
- ☞ Save the file under a different name.

To print the lists in your design you have to choose the correct template in the printer dialog.

9 Technical data

9.1 SWC SWIM CONTROLLER

- ☞ Measuring range
- ☞ 23 hours, 59 minutes, 59,9999 seconds
- ☞ Time reference
- ☞ TCXO 10.000MHz (Temperature compensated Quartz oscillator)
- ☞ Drift
- ☞ Temperature range -25 to 50 Grad Celsius: +/- 2,5ppm
- ☞ aging: +/- 1 ppm per year
- ☞ at 25 degree Celsius calibrated +/- 0.1 ppm (+/- 0.001 Sec/ hour)
- ☞ Supply
- ☞ internal: 12V Gel Cell
- ☞ external: 100-240 V, 50/60Hz
- ☞ or 12-18 V DC (Option)
- ☞ Interfaces:
- ☞ 4 x RS232 Interface (No Parity, 8 Data, 1 Stop)
- ☞ 1 x PC (38400 kBaud)
- ☞ 1 x RS1 x Displayboard 232 Displayboard galvanic separated
- ☞ 1 x RS485 Displayboard
- ☞ 1 x RS232 Online-printer and, or. 3rd party evaluation
- ☞ 1 x RS232 Video interface galvanic separated
- ☞ 2 x Timing bus Start and Turn side

9.1.1 Interface-description

Available on request!

10 Maintenance

In Progress!